

13

POMELLI



Pomelli a lobi
pag. 13.1



Pomelli a tre lobi
pag. 13.9



Pomelli zigrinati
pag. 13.11



Pomelli a croce
pag. 13.14

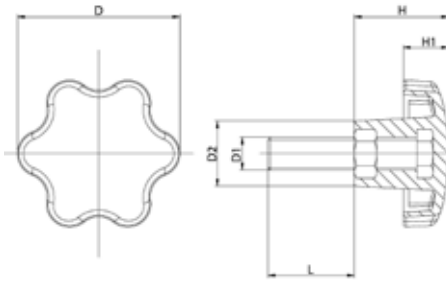

Galletti di serraggio
pag. 13.18

**MATERIALE - TRATTAMENTO SUPERFICIALE**

Impugnatura: PA6 (Poliamide)

Perno: CI 4.8 (Acciaio) zincato bianco

COLORE

Nero

NOTE

Fornibile in altre colorazioni e materiali.

Codice 	D	H	D1	L	D2	H1	Confezione (pz)
SR0EMV5300510	30	19	M5	10	14	11	100
SR0EMV5300515	30	19	M5	15	14	11	100
SR0EMV5300520	30	19	M5	20	14	11	100
SR0EMV5300525	30	19	M5	25	14	11	100
SR0EMV5300530	30	19	M5	30	14	11	100
SR0EMV5300535	30	19	M5	35	14	11	100
SR0EMV5300540	30	19	M5	40	14	11	100
SR0EMV5300610	30	19	M6	10	14	11	100
SR0EMV5300615	30	19	M6	15	14	11	100
SR0EMV5300620	30	19	M6	20	14	11	100
SR0EMV5300625	30	19	M6	25	14	11	100
SR0EMV5300630	30	19	M6	30	14	11	100
SR0EMV5300635	30	19	M6	35	14	11	100
SR0EMV5300640	30	19	M6	40	14	11	100
SR0EMV5300650	30	19	M6	50	14	11	100
SR0EMV5300815	30	19	M8	15	14	11	100
SR0EMV5300820	30	19	M8	20	14	11	100
SR0EMV5300825	30	19	M8	25	14	11	100
SR0EMV5300830	30	19	M8	30	14	11	100
SR0EMV5300835	30	19	M8	35	14	11	100
SR0EMV5300840	30	19	M8	40	14	11	100
SR0EMV5300850	30	19	M8	50	14	11	100
SR0EMV5300880	30	19	M8	80	14	11	100
SR0EMV5400610	40	25	M6	10	18	13	100
SR0EMV5400615	40	25	M6	15	18	13	100
SR0EMV5400620	40	25	M6	20	18	13	100
SR0EMV5400625	40	25	M6	25	18	13	100
SR0EMV5400630	40	25	M6	30	18	13	100
SR0EMV5400635	40	25	M6	35	18	13	100
SR0EMV5400640	40	25	M6	40	18	13	100
SR0EMV5400815	40	25	M8	15	18	13	100
SR0EMV5400820	40	25	M8	20	18	13	100
SR0EMV5400825	40	25	M8	25	18	13	100
SR0EMV5400830	40	25	M8	30	18	13	100
SR0EMV5400835	40	25	M8	35	18	13	100
SR0EMV5400840	40	25	M8	40	18	13	100
SR0EMV5400845	40	25	M8	45	18	13	100
SR0EMV5400850	40	25	M8	50	18	13	100
SR0EMV5400860	40	25	M8	60	18	13	100
SR0EMV5401015	40	25	M10	15	18	13	100
SR0EMV5401020	40	25	M10	20	18	13	100
SR0EMV5401025	40	25	M10	25	18	13	100
SR0EMV5401030	40	25	M10	30	18	13	100
SR0EMV5401035	40	25	M10	35	18	13	100
SR0EMV5401040	40	25	M10	40	18	13	100
SR0EMV5401050	40	25	M10	50	18	13	100
SR0EMV5401060	40	25	M10	60	18	13	100
SR0EMV5500615	50	28	M6	15	21	15	50
SR0EMV5500620	50	28	M6	20	21	15	50

Codice 	D	H	D1	L	D2	H1	Confezione (pz)
SR0EMV5500625	50	28	M6	25	21	15	50
SR0EMV5500630	50	28	M6	30	21	15	50
SR0EMV5500635	50	28	M6	35	21	15	50
SR0EMV5500640	50	28	M6	40	21	15	50
SR0EMV5500815	50	28	M8	15	21	15	50
SR0EMV5500820	50	28	M8	20	21	15	50
SR0EMV5500825	50	28	M8	25	21	15	50
SR0EMV5500830	50	28	M8	30	21	15	50
SR0EMV5500835	50	28	M8	35	21	15	50
SR0EMV5500840	50	28	M8	40	21	15	50
SR0EMV5500850	50	28	M8	50	21	15	50
SR0EMV5501015	50	28	M10	15	21	15	50
SR0EMV5501020	50	28	M10	20	21	15	50
SR0EMV5501025	50	28	M10	25	21	15	50
SR0EMV5501030	50	28	M10	30	21	15	50
SR0EMV5501035	50	28	M10	35	21	15	50
SR0EMV5501040	50	28	M10	40	21	15	50
SR0EMV5501220	50	28	M12	20	21	15	50
SR0EMV5501225	50	28	M12	25	21	15	50
SR0EMV5501230	50	28	M12	30	21	15	50
SR0EMV5501235	50	28	M12	35	21	15	50
SR0EMV5501240	50	28	M12	40	21	15	50
SR0EMV5501245	50	28	M12	45	21	15	50
SR0EMV5501250	50	28	M12	50	21	15	50
SR0EMV5600815	60	37	M8	15	24	18	50
SR0EMV5600820	60	37	M8	20	24	18	50
SR0EMV5600825	60	37	M8	25	24	18	50
SR0EMV5600830	60	37	M8	30	24	18	50
SR0EMV5600835	60	37	M8	35	24	18	50
SR0EMV5600840	60	37	M8	40	24	18	50
SR0EMV5600845	60	37	M8	45	24	18	50
SR0EMV5600850	60	37	M8	50	24	18	50
SR0EMV5601015	60	37	M10	15	24	18	50
SR0EMV5601020	60	37	M10	20	24	18	50
SR0EMV5601025	60	37	M10	25	24	18	50
SR0EMV5601030	60	37	M10	30	24	18	50
SR0EMV5601035	60	37	M10	35	24	18	50
SR0EMV5601040	60	37	M10	40	24	18	50
SR0EMV5601045	60	37	M10	45	24	18	50
SR0EMV5601050	60	37	M10	50	24	18	50
SR0EMV5601060	60	37	M10	60	24	18	50
SR0EMV5601220	60	37	M12	20	24	18	50
SR0EMV5601225	60	37	M12	25	24	18	50
SR0EMV5601230	60	37	M12	30	24	18	50
SR0EMV5601235	60	37	M12	35	24	18	50
SR0EMV5601240	60	37	M12	40	24	18	50
SR0EMV5601250	60	37	M12	50	24	18	50
SR0EMV5601260	60	37	M12	60	24	18	50
SR0EMV5701020	70	41	M10	20	24	21	50



MATERIALE - TRATTAMENTO SUPERFICIALE

Impugnatura: PA6 (Poliamide)

Perno: CI 4.8 (Acciaio) zincato bianco

COLORE

NE Nero

NOTE

Fornibile in altre colorazioni e materiali.

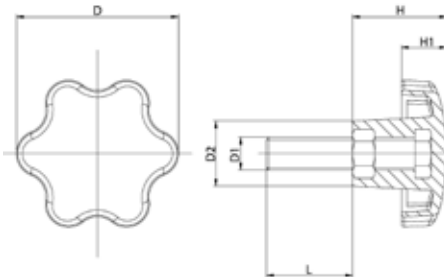

Codice NE	D	H	D1	L	D2	H1	Confezione (pz)
SR0EMV5701025	70	41	M10	25	24	21	50
SR0EMV5701030	70	41	M10	30	24	21	50
SR0EMV5701040	70	41	M10	40	24	21	50
SR0EMV5701050	70	41	M10	50	24	21	50
SR0EMV5701060	70	41	M10	60	24	21	50
SR0EMV5701220	70	41	M12	20	24	21	50
SR0EMV5701230	70	41	M12	30	24	21	50
SR0EMV5701240	70	41	M12	40	24	21	50
SR0EMV5701250	70	41	M12	50	24	21	50
SR0EMV5701260	70	41	M12	60	24	21	50
SR0EMV5701270	70	41	M12	70	24	21	50
SR0EMV5701280	70	41	M12	80	24	21	50
SR0EMV5701430	70	41	M14	30	24	21	50
SR0EMV5701440	70	41	M14	40	24	21	50
SR0EMV5701450	70	41	M14	50	24	21	50

Codice NE	D	H	D1	L	D2	H1	Confezione (pz)
SR0EMV5701460	70	41	M14	60	24	21	50
SR0EMV5701470	70	41	M14	70	24	21	50
SR0EMV5701480	70	41	M14	80	24	21	50
SR0EMV5901240	90	56	M12	40	34	25	25
SR0EMV5901250	90	56	M12	50	34	25	25
SR0EMV5901260	90	56	M12	60	34	25	25
SR0EMV5901270	90	56	M12	70	34	25	25
SR0EMV5901280	90	56	M12	80	34	25	25
SR0EMV5901440	90	56	M14	40	34	25	25
SR0EMV5901450	90	56	M14	50	34	25	25
SR0EMV5901460	90	56	M14	60	34	25	25
SR0EMV5901470	90	56	M14	70	34	25	25
SR0EMV5901480	90	56	M14	80	34	25	25

POMELLO 6 LOBI
BFP

MATERIALE

Impugnatura: PA6 (Poliamide)

Boccola: OT58 (Ottone)

COLORE

NE Nero

NOTE

Fornibile in altre colorazioni e materiali.

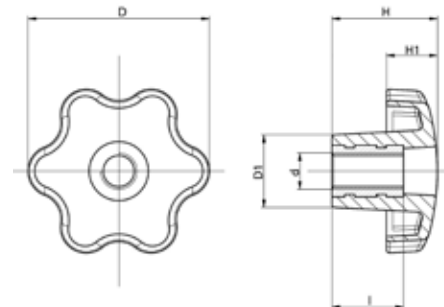

Codice NE	D	H	d	l	D1	H1	Confezione (pz)
SR0EMV5300599	30	19	M5	10	14	11	100
SR0EMV5300699	30	19	M6	10	14	11	100
SR0EMV5300899	30	19	M8	10	14	11	100
SR0EMV5400699	40	25	M6	15	18	13	100
SR0EMV5400899	40	25	M8	15	18	13	100
SR0EMV5401099	40	25	M10	15	18	13	100
SR0EMV5500699	50	28	M6	15	21	15	50
SR0EMV5500899	50	28	M8	15	21	15	50
SR0EMV5501099	50	28	M10	15	21	15	50
SR0EMV5501299	50	28	M12	15	21	15	50
SR0EMV5600899	60	37	M8	20	24	18	50

Codice NE	D	H	d	l	D1	H1	Confezione (pz)
SR0EMV5601099	60	37	M10	20	24	18	50
SR0EMV5601299	60	37	M12	20	24	18	50
SR0EMV5701099	70	41	M10	20	24	21	50
SR0EMV5701299	70	41	M12	20	24	21	50
SR0EMV5701499	70	41	M14	20	24	21	50
SR0EMV5701699	70	41	M16	20	24	21	50
SR0EMV5901299	90	56	M12	20	34	25	25
SR0EMV5901499	90	56	M14	20	34	25	25
SR0EMV5901699	90	56	M16	20	34	25	25
SR0EMV5901899	90	56	M18	20	34	25	25

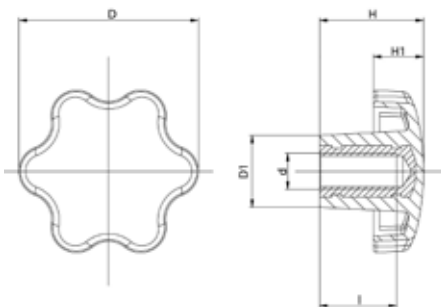
**MATERIALE**

Impugnatura: PA6 (Poliammide)

Boccola: OT58 (Ottone)

COLORE

Nero

NOTE

Fornibile in altre colorazioni e materiali.

Codice 	D	H	d	l	D1	H1	Confezione (pz)
SR0EMV5300500	30	19	M5	9	14	11	100
SR0EMV5300600	30	19	M6	9	14	11	100
SR0EMV5300800	30	19	M8	12	14	11	100
SR0EMV5400600	40	25	M6	14	18	13	100
SR0EMV5400800	40	25	M8	17	18	13	100
SR0EMV5401000	40	25	M10	17	18	13	100
SR0EMV5500600	50	28	M6	9	21	15	50
SR0EMV5500800	50	28	M8	12	21	15	50
SR0EMV5501000	50	28	M10	17	21	15	50
SR0EMV5501200	50	28	M12	17	21	15	50
SR0EMV5600800	60	37	M8	17	24	18	50

Codice 	D	H	d	l	D1	H1	Confezione (pz)
SR0EMV5601000	60	37	M10	17	24	18	50
SR0EMV5601200	60	37	M12	17	24	18	50
SR0EMV5701000	70	41	M10	24	24	21	50
SR0EMV5701200	70	41	M12	24	24	21	50
SR0EMV5701400	70	41	M14	24	24	21	50
SR0EMV5701600	70	41	M16	24	24	21	50
SR0EMV5901200	90	56	M12	24	34	25	25
SR0EMV5901400	90	56	M14	24	34	25	25
SR0EMV5901600	90	56	M16	24	34	25	25
SR0EMV5901800	90	56	M18	35	34	25	25

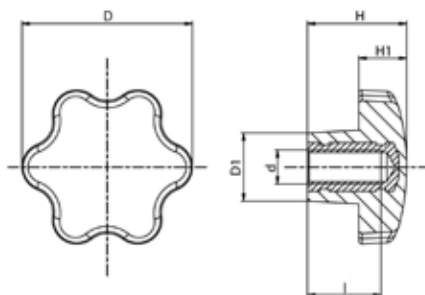
**MATERIALE**

Impugnatura: PA6 (Poliammide)

Boccola: OT58 (Ottone)

COLORE

Nero

NOTEFornibile in altre colorazioni e materiali.
Compatibile con il settore alimentare.

Codice 	D	H	d	l	D1	H1	Confezione (pz)
SR0EMV53A0500	30	19	M5	9	14	11	100
SR0EMV53A0600	30	19	M6	9	14	11	100
SR0EMV53A0800	30	19	M8	12	14	11	100
SR0EMV54A0600	40	25	M6	14	18	13	100
SR0EMV54A0800	40	25	M8	17	18	13	100
SR0EMV54A1000	40	25	M10	17	18	13	100
SR0EMV55A0600	50	28	M6	9	21	15	50
SR0EMV55A0800	50	28	M8	12	21	15	50
SR0EMV55A1000	50	28	M10	17	21	15	50
SR0EMV55A1200	50	28	M12	17	21	15	50
SR0EMV56A0800	60	37	M8	17	24	18	50

Codice 	D	H	d	l	D1	H1	Confezione (pz)
SR0EMV56A1000	60	37	M10	17	24	18	50
SR0EMV56A1200	60	37	M12	17	24	18	50
SR0EMV57A1000	70	41	M10	24	24	21	50
SR0EMV57A1200	70	41	M12	24	24	21	50
SR0EMV57A1400	70	41	M14	24	24	21	50
SR0EMV57A1600	70	41	M16	24	24	21	50
SR0EMV59A1200	90	56	M12	24	34	25	25
SR0EMV59A1400	90	56	M14	24	34	25	25
SR0EMV59A1600	90	56	M16	24	34	25	25
SR0EMV59A1800	90	56	M18	35	34	25	25



MATERIALE - TRATTAMENTO SUPERFICIALE

Impugnatura: PA6 (Poliamide)

Perno: CI 4.8 (Acciaio) zincato bianco

COLORE

NE Nero

NOTE

Fornibile in altre colorazioni e materiali.
Compatibile con il settore alimentare.

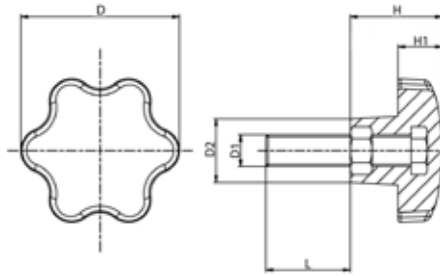

Codice NE	D	H	D1	L	D2	H1	Confezione (pz)
SR0EMV53A0520	30	19	M5	20	14	11	100
SR0EMV53A0530	30	19	M5	30	14	11	100
SR0EMV53A0540	30	19	M5	40	14	11	100
SR0EMV53A0620	30	19	M6	20	14	11	100
SR0EMV53A0630	30	19	M6	30	14	11	100
SR0EMV53A0640	30	19	M6	40	14	11	100
SR0EMV53A0820	30	19	M8	20	14	11	100
SR0EMV53A0830	30	19	M8	30	14	11	100
SR0EMV53A0840	30	19	M8	40	14	11	100
SR0EMV53A0850	30	19	M8	50	14	11	100
SR0EMV54A0610	40	25	M6	10	18	13	100
SR0EMV54A0620	40	25	M6	20	18	13	100
SR0EMV54A0630	40	25	M6	30	18	13	100
SR0EMV54A0640	40	25	M6	40	18	13	100
SR0EMV54A0820	40	25	M8	20	18	13	100
SR0EMV54A0830	40	25	M8	30	18	13	100
SR0EMV54A0840	40	25	M8	40	18	13	100
SR0EMV54A0850	40	25	M8	50	18	13	100
SR0EMV54A1020	40	25	M10	20	18	13	100
SR0EMV54A1030	40	25	M10	30	18	13	100
SR0EMV54A1040	40	25	M10	40	18	13	100
SR0EMV54A1050	40	25	M10	50	18	13	100
SR0EMV54A1060	40	25	M10	60	18	13	100
SR0EMV55A0620	50	28	M6	20	21	15	50
SR0EMV55A0630	50	28	M6	30	21	15	50
SR0EMV55A0640	50	28	M6	40	21	15	50
SR0EMV55A0820	50	28	M8	20	21	15	50
SR0EMV55A0830	50	28	M8	30	21	15	50
SR0EMV55A0840	50	28	M8	40	21	15	50
SR0EMV55A0850	50	28	M8	50	21	15	50
SR0EMV55A1020	50	28	M10	20	21	15	50
SR0EMV55A1030	50	28	M10	30	21	15	50
SR0EMV55A1040	50	28	M10	40	21	15	50
SR0EMV55A1220	50	28	M12	20	21	15	50
SR0EMV55A1230	50	28	M12	30	21	15	50
SR0EMV55A1240	50	28	M12	40	21	15	50
SR0EMV55A1250	50	28	M12	50	21	15	50
SR0EMV56A0820	60	37	M8	20	24	18	50
SR0EMV56A0830	60	37	M8	30	24	18	50
SR0EMV56A0840	60	37	M8	40	24	18	50
SR0EMV56A0850	60	37	M8	50	24	18	50
SR0EMV56A1020	60	37	M10	20	24	18	50
SR0EMV56A1030	60	37	M10	30	24	18	50
SR0EMV56A1040	60	37	M10	40	24	18	50
SR0EMV56A1050	60	37	M10	50	24	18	50

Codice NE	D	H	D1	L	D2	H1	Confezione (pz)
SR0EMV56A1060	60	37	M10	60	24	18	50
SR0EMV56A1220	60	37	M12	20	24	18	50
SR0EMV56A1230	60	37	M12	30	24	18	50
SR0EMV56A1240	60	37	M12	40	24	18	50
SR0EMV56A1250	60	37	M12	50	24	18	50
SR0EMV56A1260	60	37	M12	60	24	18	50
SR0EMV57A1020	70	41	M10	20	24	21	50
SR0EMV57A1030	70	41	M10	30	24	21	50
SR0EMV57A1040	70	41	M10	40	24	21	50
SR0EMV57A1050	70	41	M10	50	24	21	50
SR0EMV57A1060	70	41	M10	60	24	21	50
SR0EMV57A1220	70	41	M12	20	24	21	50
SR0EMV57A1230	70	41	M12	30	24	21	50
SR0EMV57A1240	70	41	M12	40	24	21	50
SR0EMV57A1250	70	41	M12	50	24	21	50
SR0EMV57A1260	70	41	M12	60	24	21	50
SR0EMV57A1270	70	41	M12	70	24	21	50
SR0EMV57A1280	70	41	M12	80	24	21	50
SR0EMV57A1430	70	41	M14	30	24	21	50
SR0EMV57A1440	70	41	M14	40	24	21	50
SR0EMV57A1450	70	41	M14	50	24	21	50
SR0EMV57A1460	70	41	M14	60	24	21	50
SR0EMV57A1470	70	41	M14	70	24	21	50
SR0EMV57A1480	70	41	M14	80	24	21	50
SR0EMV59A1240	90	56	M12	40	34	25	25
SR0EMV59A1250	90	56	M12	50	34	25	25
SR0EMV59A1260	90	56	M12	60	34	25	25
SR0EMV59A1270	90	56	M12	70	34	25	25
SR0EMV59A1280	90	56	M12	80	34	25	25
SR0EMV59A1440	90	56	M14	40	34	25	25
SR0EMV59A1450	90	56	M14	50	34	25	25
SR0EMV59A1460	90	56	M14	60	34	25	25
SR0EMV59A1470	90	56	M14	70	34	25	25
SR0EMV59A1480	90	56	M14	80	34	25	25

1
2
3
4
5
6
7
8
9
10
11
12
13
14
15
16
17
18
19
20
21

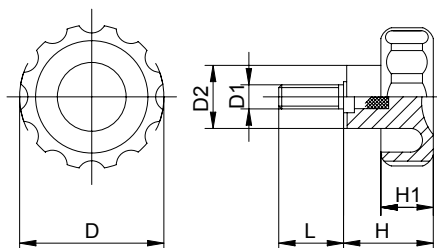

MATERIALE - TRATTAMENTO SUPERFICIALE

Impugnatura: PA6 (Poliammide)

Perno: CI 4.8 (Acciaio) zincato bianco

COLORE

NE Nero

NOTE

Fornibile in altre colorazioni e materiali.

Codice NE	D	H	D1	L	D2	H1	Confezione (pz)
SR0EMV1200410	20	16	M4	10	12	9	100
SR0EMV1200415	20	16	M4	15	12	9	100
SR0EMV1200420	20	16	M4	20	12	9	100
SR0EMV1200430	20	16	M4	30	12	9	100
SR0EMV1200510	20	16	M5	10	12	9	100
SR0EMV1200515	20	16	M5	15	12	9	100
SR0EMV1200520	20	16	M5	20	12	9	100
SR0EMV1200525	20	16	M5	25	12	9	100
SR0EMV1200530	20	16	M5	30	12	9	100
SR0EMV1200535	20	16	M5	35	12	9	100
SR0EMV1200540	20	16	M5	40	12	9	100
SR0EMV1300510	30	22	M5	10	16	13	100
SR0EMV1300515	30	22	M5	15	16	13	100
SR0EMV1300520	30	22	M5	20	16	13	100
SR0EMV1300525	30	22	M5	25	16	13	100
SR0EMV1300530	30	22	M5	30	16	13	100
SR0EMV1300540	30	22	M5	40	16	13	100
SR0EMV1200610	20	16	M6	10	12	9	100
SR0EMV1200615	20	16	M6	15	12	9	100
SR0EMV1200620	20	16	M6	20	12	9	100
SR0EMV1200625	20	16	M6	25	12	9	100
SR0EMV1200630	20	16	M6	30	12	9	100
SR0EMV1200635	20	16	M6	35	12	9	100
SR0EMV1200640	20	16	M6	40	12	9	100
SR0EMV1200645	20	16	M6	45	12	9	100
SR0EMV1200650	20	16	M6	50	12	9	100
SR0EMV1200655	20	16	M6	55	12	9	100
SR0EMV1200660	20	16	M6	60	12	9	100
SR0EMV1300610	30	22	M6	10	16	13	100
SR0EMV1300615	30	22	M6	15	16	13	100
SR0EMV1300620	30	22	M6	20	16	13	100
SR0EMV1300625	30	22	M6	25	16	13	100
SR0EMV1300630	30	22	M6	30	16	13	100
SR0EMV1300635	30	22	M6	35	16	13	100
SR0EMV1300640	30	22	M6	40	16	13	100
SR0EMV1300645	30	22	M6	45	16	13	100
SR0EMV1300650	30	22	M6	50	16	13	100
SR0EMV1300660	30	22	M6	60	16	13	100
SR0EMV1300665	30	22	M6	65	16	13	100
SR0EMV1300670	30	22	M6	70	16	13	100
SR0EMV1400610	40	27	M6	10	20	16	100
SR0EMV1400615	40	27	M6	15	20	16	100
SR0EMV1400620	40	27	M6	20	20	16	100

Codice NE	D	H	D1	L	D2	H1	Confezione (pz)
SR0EMV1400625	40	27	M6	25	20	16	100
SR0EMV1400630	40	27	M6	30	20	16	100
SR0EMV1400635	40	27	M6	35	20	16	100
SR0EMV1400640	40	27	M6	40	20	16	100
SR0EMV1400645	40	27	M6	45	20	16	100
SR0EMV1400650	40	27	M6	50	20	16	100
SR0EMV1400660	40	27	M6	60	20	16	100
SR0EMV1300810	30	22	M8	10	16	13	100
SR0EMV1300815	30	22	M8	15	16	13	100
SR0EMV1300820	30	22	M8	20	16	13	100
SR0EMV1300825	30	22	M8	25	16	13	100
SR0EMV1300830	30	22	M8	30	16	13	100
SR0EMV1300835	30	22	M8	35	16	13	100
SR0EMV1300840	30	22	M8	40	16	13	100
SR0EMV1300845	30	22	M8	45	16	13	100
SR0EMV1300850	30	22	M8	50	16	13	100
SR0EMV1300855	30	22	M8	55	16	13	100
SR0EMV1300860	30	22	M8	60	16	13	100
SR0EMV1400810	40	27	M8	10	20	16	100
SR0EMV1400815	40	27	M8	15	20	16	100
SR0EMV1400820	40	27	M8	20	20	16	100
SR0EMV1400825	40	27	M8	25	20	16	100
SR0EMV1400830	40	27	M8	30	20	16	100
SR0EMV1400835	40	27	M8	35	20	16	100
SR0EMV1400840	40	27	M8	40	20	16	100
SR0EMV1400845	40	27	M8	45	20	16	100
SR0EMV1400850	40	27	M8	50	20	16	100
SR0EMV1400855	40	27	M8	55	20	16	100
SR0EMV1400860	40	27	M8	60	20	16	100
SR0EMV1400865	40	27	M8	65	20	16	100
SR0EMV1400870	40	27	M8	70	20	16	100
SR0EMV1500810	50	32	M8	10	23	20	50
SR0EMV1500815	50	32	M8	15	23	20	50
SR0EMV1500820	50	32	M8	20	23	20	50
SR0EMV1500825	50	32	M8	25	23	20	50
SR0EMV1500830	50	32	M8	30	23	20	50
SR0EMV1500835	50	32	M8	35	23	20	50
SR0EMV1500840	50	32	M8	40	23	20	50
SR0EMV1500845	50	32	M8	45	23	20	50
SR0EMV1500850	50	32	M8	50	23	20	50
SR0EMV1500855	50	32	M8	55	23	20	50
SR0EMV1500860	50	32	M8	60	23	20	50
SR0EMV1500865	50	32	M8	65	23	20	50



MATERIALE - TRATTAMENTO SUPERFICIALE

Impugnatura: PA6 (Poliamide)

Perno: CI 4.8 (Acciaio) zincato bianco

COLORE

NE Nero

NOTE

Fornibile in altre colorazioni e materiali.

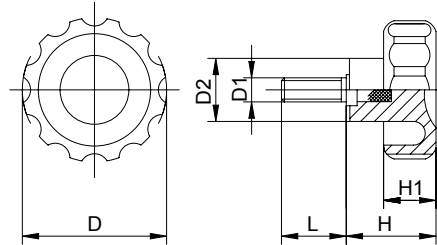

Codice NE	D	H	D1	L	D2	H1	Confezione (pz)
SR0EMV1500870	50	32	M8	70	23	20	50
SR0EMV1500875	50	32	M8	75	23	20	50
SR0EMV1500880	50	32	M8	80	23	20	50
SR0EMV1600810	60	36	M8	10	26	22	50
SR0EMV1600815	60	36	M8	15	26	22	50
SR0EMV1600820	60	36	M8	20	26	22	50
SR0EMV1600825	60	36	M8	25	26	22	50
SR0EMV1600830	60	36	M8	30	26	22	50
SR0EMV1600835	60	36	M8	35	26	22	50
SR0EMV1600840	60	36	M8	40	26	22	50
SR0EMV1600845	60	36	M8	45	26	22	50
SR0EMV1600850	60	36	M8	50	26	22	50
SR0EMV1600860	60	36	M8	60	26	22	50
SR0EMV1401015	40	27	M10	15	20	16	100
SR0EMV1401020	40	27	M10	20	20	16	100
SR0EMV1401025	40	27	M10	25	20	16	100
SR0EMV1401030	40	27	M10	30	20	16	100
SR0EMV1401035	40	27	M10	35	20	16	100
SR0EMV1401040	40	27	M10	40	20	16	100
SR0EMV1401050	40	27	M10	50	20	16	100
SR0EMV1401060	40	27	M10	60	20	16	100
SR0EMV1501015	50	32	M10	15	23	20	50
SR0EMV1501020	50	32	M10	20	23	20	50
SR0EMV1501025	50	32	M10	25	23	20	50
SR0EMV1501030	50	32	M10	30	23	20	50
SR0EMV1501035	50	32	M10	35	23	20	50
SR0EMV1501040	50	32	M10	40	23	20	50
SR0EMV1501050	50	32	M10	50	23	20	50
SR0EMV1501055	50	32	M10	55	23	20	50
SR0EMV1501060	50	32	M10	60	23	20	50
SR0EMV1501070	50	32	M10	70	23	20	50
SR0EMV1501075	50	32	M10	75	23	20	50
SR0EMV1501080	50	32	M10	80	23	20	50
SR0EMV1601015	60	36	M10	15	26	22	50
SR0EMV1601020	60	36	M10	20	26	22	50
SR0EMV1601025	60	36	M10	25	26	22	50
SR0EMV1601030	60	36	M10	30	26	22	50
SR0EMV1601035	60	36	M10	35	26	22	50
SR0EMV1601040	60	36	M10	40	26	22	50
SR0EMV1601045	60	36	M10	45	26	22	50
SR0EMV1601050	60	36	M10	50	26	22	50
SR0EMV1601060	60	36	M10	60	26	22	50
SR0EMV1601070	60	36	M10	70	26	22	50

Codice NE	D	H	D1	L	D2	H1	Confezione (pz)
SR0EMV1601075	60	36	M10	75	26	22	50
SR0EMV1601080	60	36	M10	80	26	22	50
SR0EMV1701015	70	40	M10	15	27	24	50
SR0EMV1701020	70	40	M10	20	27	24	50
SR0EMV1701025	70	40	M10	25	27	24	50
SR0EMV1701030	70	40	M10	30	27	24	50
SR0EMV1701035	70	40	M10	35	27	24	50
SR0EMV1701040	70	40	M10	40	27	24	50
SR0EMV1701050	70	40	M10	50	27	24	50
SR0EMV1701060	70	40	M10	60	27	24	50
SR0EMV1801030	80	42	M10	30	30	25	50
SR0EMV1501220	50	32	M12	20	23	20	50
SR0EMV1501230	50	32	M12	30	23	20	50
SR0EMV1501240	50	32	M12	40	23	20	50
SR0EMV1501250	50	32	M12	50	23	20	50
SR0EMV1501260	50	32	M12	60	23	20	50
SR0EMV1601220	60	36	M12	20	26	22	50
SR0EMV1601225	60	36	M12	25	26	22	50
SR0EMV1601230	60	36	M12	30	26	22	50
SR0EMV1601235	60	36	M12	35	26	22	50
SR0EMV1601240	60	36	M12	40	26	22	50
SR0EMV1601250	60	36	M12	50	26	22	50
SR0EMV1601260	60	36	M12	60	26	22	50
SR0EMV1701220	70	40	M12	20	27	24	50
SR0EMV1701230	70	40	M12	30	27	24	50
SR0EMV1701240	70	40	M12	40	27	24	50
SR0EMV1701250	70	40	M12	50	27	24	50
SR0EMV1701260	70	40	M12	60	27	24	50
SR0EMV1801220	80	42	M12	20	30	25	50
SR0EMV1801230	80	42	M12	30	30	25	50
SR0EMV1801240	80	42	M12	40	30	25	50
SR0EMV1801250	80	42	M12	50	30	25	50
SR0EMV1801260	80	42	M12	60	30	25	50
SR0EMV1701430	70	40	M14	30	27	24	50
SR0EMV1701440	70	40	M14	40	27	24	50
SR0EMV1701450	70	40	M14	50	27	24	50
SR0EMV1701460	70	40	M14	60	27	24	50
SR0EMV1801430	80	42	M14	30	30	25	50

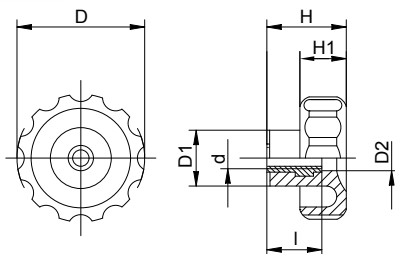
**MATERIALE**

Impugnatura: PA6 (Poliamide)

Boccola: OT58 (Ottone)

COLORE

Nero

NOTE

Fornibile in altre colorazioni e materiali.

Codice 	D	H	d	l	D1	H1	D2	Confezione (pz)
SR0EMV1200599	20	16	M5	10	12	9	8	100
SR0EMV1200699	20	16	M6	10	12	9	8	100
SR0EMV1300599	30	22	M5	10	16	13	10	100
SR0EMV1300699	30	22	M6	10	16	13	10	100
SR0EMV1300899	30	22	M8	10	16	13	10	100
SR0EMV1400699	40	27	M6	15	20	16	12	100
SR0EMV1400899	40	27	M8	15	20	16	12	100
SR0EMV1401099	40	27	M10	15	20	16	12	100
SR0EMV1500899	50	32	M8	20	23	20	14	50
SR0EMV1501099	50	32	M10	20	23	20	14	50
SR0EMV1501299	50	32	M12	20	23	20	14	50

Codice 	D	H	d	l	D1	H1	D2	Confezione (pz)
SR0EMV1600899	60	36	M8	20	26	22	14	50
SR0EMV1601099	60	36	M10	20	26	22	14	50
SR0EMV1601299	60	36	M12	20	26	22	14	50
SR0EMV1701099	70	40	M10	20	27	24	16	50
SR0EMV1701299	70	40	M12	20	27	24	16	50
SR0EMV1701499	70	40	M14	20	27	24	16	50
SR0EMV1701699	70	40	M16	20	27	24	16	50
SR0EMV1801299	80	42	M12	20	30	25	18	50
SR0EMV1801499	80	42	M14	20	30	25	18	50
SR0EMV1801699	80	42	M16	20	30	25	18	50



MATERIALE

Impugnatura: PA6 (Poliamide)

Boccola: OT58 (Ottone)

COLORE

NE Nero

NOTE

Fornibile in altre colorazioni e materiali.

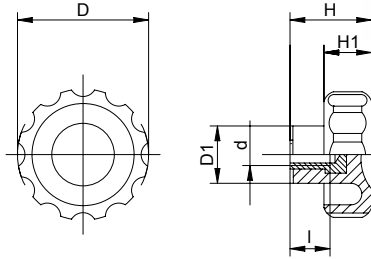

Codice NE	D	H	d	l	D1	H1	Confezione (pz)
SR0EMV1200400	20	16	M4	9	12	9	100
SR0EMV1200500	20	16	M5	9	12	9	100
SR0EMV1200600	20	16	M6	9	12	9	100
SR0EMV1300500	30	22	M5	9	16	13	100
SR0EMV1300600	30	22	M6	9	16	13	100
SR0EMV1300800	30	22	M8	12	16	13	100
SR0EMV1400600	40	27	M6	14	20	16	100
SR0EMV1400800	40	27	M8	17	20	16	100
SR0EMV1401000	40	27	M10	17	20	16	100
SR0EMV1500600	50	32	M6	17	23	20	50
SR0EMV1500800	50	32	M8	17	23	20	50
SR0EMV1501000	50	32	M10	17	23	20	50

Codice NE	D	H	d	l	D1	H1	Confezione (pz)
SR0EMV1501200	50	32	M12	17	23	20	50
SR0EMV1600800	60	36	M8	17	26	22	50
SR0EMV1601000	60	36	M10	17	26	22	50
SR0EMV1601200	60	36	M12	17	26	22	50
SR0EMV1701000	70	40	M10	25	27	24	50
SR0EMV1701200	70	40	M12	25	27	24	50
SR0EMV1701400	70	40	M14	25	27	24	50
SR0EMV1701600	70	40	M16	25	27	24	50
SR0EMV1801000	80	42	M10	25	30	25	50
SR0EMV1801200	80	42	M12	25	30	25	50
SR0EMV1801400	80	42	M14	25	30	25	50
SR0EMV1801600	80	42	M16	25	30	25	50

- 1
- 2
- 3
- 4
- 5
- 6
- 7
- 8
- 9
- 10
- 11
- 12
- 13
- 14
- 15
- 16
- 17
- 18
- 19
- 20
- 21



MATERIALE - TRATTAMENTO SUPERFICIALE

Impugnatura: PA6 (Poliammide)

Perno: CI 4.8 (Acciaio) zincato bianco

COLORE

Nero

NOTE

Fornibile in altre colorazioni e materiali.

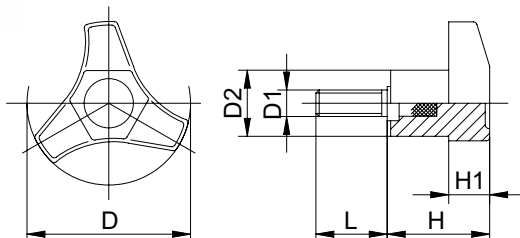

Codice	D	H	D1	L	D2	H1	Confezione (pz)
SR0EMV6450610	45	27	M6	10	17	11	100
SR0EMV6450615	45	27	M6	15	17	11	100
SR0EMV6450620	45	27	M6	20	17	11	100
SR0EMV6450625	45	27	M6	25	17	11	100
SR0EMV6450630	45	27	M6	30	17	11	100
SR0EMV6450635	45	27	M6	35	17	11	100
SR0EMV6450640	45	27	M6	40	17	11	100
SR0EMV6450810	45	27	M8	10	17	11	100
SR0EMV6450815	45	27	M8	15	17	11	100
SR0EMV6450820	45	27	M8	20	17	11	100
SR0EMV6450825	45	27	M8	25	17	11	100
SR0EMV6450830	45	27	M8	30	17	11	100
SR0EMV6450835	45	27	M8	35	17	11	100
SR0EMV6450840	45	27	M8	40	17	11	100
SR0EMV6450850	45	27	M8	50	17	11	100
SR0EMV6450860	45	27	M8	60	17	11	100
SR0EMV6451015	45	27	M10	15	17	11	100
SR0EMV6451020	45	27	M10	20	17	11	100
SR0EMV6451025	45	27	M10	25	17	11	100
SR0EMV6451030	45	27	M10	30	17	11	100
SR0EMV6451035	45	27	M10	35	17	11	100
SR0EMV6451040	45	27	M10	40	17	11	100
SR0EMV6451050	45	27	M10	50	17	11	100
SR0EMV6451060	45	27	M10	60	17	11	100

Codice	D	H	D1	L	D2	H1	Confezione (pz)
SR0EMV6550610	55	32	M6	10	20	14	100
SR0EMV6550615	55	32	M6	15	20	14	100
SR0EMV6550620	55	32	M6	20	20	14	100
SR0EMV6550625	55	32	M6	25	20	14	100
SR0EMV6550630	55	32	M6	30	20	14	100
SR0EMV6550635	55	32	M6	35	20	14	100
SR0EMV6550640	55	32	M6	40	20	14	100
SR0EMV6550810	55	32	M8	10	20	14	100
SR0EMV6550815	55	32	M8	15	20	14	100
SR0EMV6550820	55	32	M8	20	20	14	100
SR0EMV6550825	55	32	M8	25	20	14	100
SR0EMV6550830	55	32	M8	30	20	14	100
SR0EMV6550835	55	32	M8	35	20	14	100
SR0EMV6550840	55	32	M8	40	20	14	100
SR0EMV6550850	55	32	M8	50	20	14	100
SR0EMV6550860	55	32	M8	60	20	14	100
SR0EMV6551015	55	32	M10	15	20	14	100
SR0EMV6551020	55	32	M10	20	20	14	100
SR0EMV6551025	55	32	M10	25	20	14	100
SR0EMV6551030	55	32	M10	30	20	14	100
SR0EMV6551035	55	32	M10	35	20	14	100
SR0EMV6551040	55	32	M10	40	20	14	100
SR0EMV6551050	55	32	M10	50	20	14	100
SR0EMV6551060	55	32	M10	60	20	14	100



MATERIALE

Impugnatura: PA6 (Poliammide)

Boccola: OT58 (Ottone)

COLORE

Nero

NOTE

Fornibile in altre colorazioni e materiali.

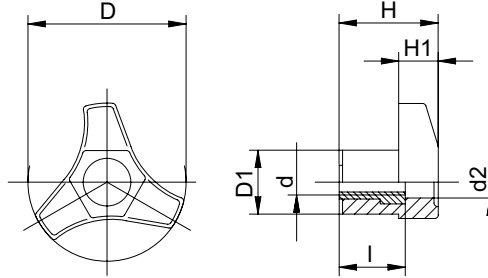

Codice	D	H	d	l	H1	D1	d2	Confezione (pz)
SR0EMV6450699	45	27	M6	15	11	17	7,5	100
SR0EMV6450899	45	27	M8	15	11	17	9,5	100
SR0EMV6451099	45	27	M10	15	11	17	11,5	100

Codice	D	H	d	l	H1	D1	d2	Confezione (pz)
SR0EMV6550899	55	32	M8	20	14	20	9,5	50
SR0EMV6551099	55	32	M10	20	14	20	11,5	50
SR0EMV6551299	55	32	M12	20	14	20	13,5	50

MATERIALE

Impugnatura: PA6 (Poliammide)

Boccola: OT58 (Ottone)

COLORE

Nero

NOTE

Fornibile in altre colorazioni e materiali.

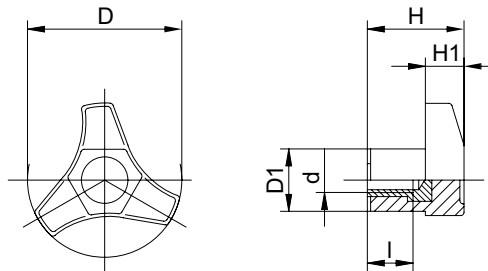

Codice	D	H	d	l	D1	H1	Confezione (pz)
SR0EMV6450600	45	27	M6	13	17	11	100
SR0EMV6450800	45	27	M8	16	17	11	100
SR0EMV6451000	45	27	M10	17	17	11	100

Codice	D	H	d	l	D1	H1	Confezione (pz)
SR0EMV6550800	55	32	M8	16	20	14	50
SR0EMV6551000	55	32	M10	17	20	14	50
SR0EMV6551200	55	32	M12	17	20	14	50

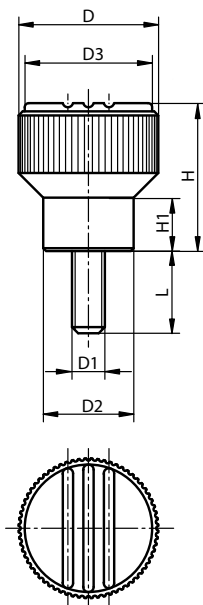

MATERIALE - TRATTAMENTO SUPERFICIALE

Impugnatura: TMP (Termoplastico)
Perno: Cl 5.8 (Acciaio) zincato bianco
AISI303 (Inox)

COLORE

Impugnatura: GN Grigio nerastro
GV Grigio RAL 7021
G5 Grigio RAL 7035
R2 Rosso RAL 3020
G1 Giallo RAL 1021

Codice Acciaio	Codice Inox	Colore tappo	D	H	D1	L	D2	D3	H1	Confezione (pz)
KP0247105X10	KP02470105X10	GV	21	22	M5	10	14	19	8	1
KP0247105X12	KP02470105X12	GV	21	22	M5	12	14	19	8	1
KP0247105X15	KP02470105X15	GV	21	22	M5	15	14	19	8	1
KP0247105X20	KP02470105X20	GV	21	22	M5	20	14	19	8	1
KP0247105X25	KP02470105X25	GV	21	22	M5	25	14	19	8	1
KP02471055X10	KP024701055X10	G5	21	22	M5	10	14	19	8	1
KP02471055X12	KP024701055X12	G5	21	22	M5	12	14	19	8	1
KP02471055X15	KP024701055X15	G5	21	22	M5	15	14	19	8	1
KP02471055X20	KP024701055X20	G5	21	22	M5	20	14	19	8	1
KP02471055X25	KP024701055X25	G5	21	22	M5	25	14	19	8	1
KP02471056X10	KP024701056X10	R2	21	22	M5	10	14	19	8	1
KP02471056X12	KP024701056X12	R2	21	22	M5	12	14	19	8	1
KP02471056X15	KP024701056X15	R2	21	22	M5	15	14	19	8	1
KP02471056X20	KP024701056X20	R2	21	22	M5	20	14	19	8	1
KP02471056X25	KP024701056X25	R2	21	22	M5	25	14	19	8	1
KP02471057X10	KP024701057X10	G1	21	22	M5	10	14	19	8	1
KP02471057X12	KP024701057X12	G1	21	22	M5	12	14	19	8	1
KP02471057X15	KP024701057X15	G1	21	22	M5	15	14	19	8	1
KP02471057X20	KP024701057X20	G1	21	22	M5	20	14	19	8	1
KP02471057X25	KP024701057X25	G1	21	22	M5	25	14	19	8	1
KP0247106X15	KP02470106X15	GV	21	22	M6	15	14	19	8	1
KP0247106X20	KP02470106X20	GV	21	22	M6	20	14	19	8	1
KP0247106X25	KP02470106X25	GV	21	22	M6	25	14	19	8	1
KP0247106X30	KP02470106X30	GV	21	22	M6	30	14	19	8	1
KP02471065X15	KP024701065X15	G5	21	22	M6	15	14	19	8	1
KP02471065X20	KP024701065X20	G5	21	22	M6	20	14	19	8	1
KP02471065X25	KP024701065X25	G5	21	22	M6	25	14	19	8	1
KP02471065X30	KP024701065X30	G5	21	22	M6	30	14	19	8	1
KP02471066X15	KP024701066X15	R2	21	22	M6	15	14	19	8	1
KP02471066X20	KP024701066X20	R2	21	22	M6	20	14	19	8	1
KP02471066X25	KP024701066X25	R2	21	22	M6	25	14	19	8	1
KP02471066X30	KP024701066X30	R2	21	22	M6	30	14	19	8	1



MATERIALE - TRATTAMENTO SUPERFICIALE

Impugnatura: TMP (Termoplastico)
Perno: Cl 5.8 (Acciaio) zincato bianco
AISI303 (Inox)

COLORE

Impugnatura: GN Grigio nerastro
Tappo: GV Grigio RAL 7021
G5 Grigio RAL 7035
R2 Rosso RAL 3020
G1 Giallo RAL 1021

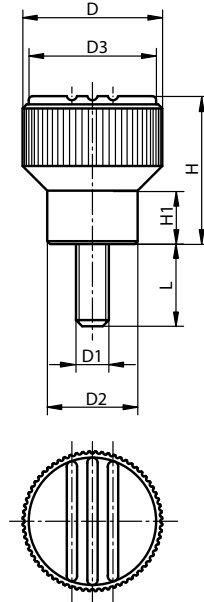

Codice Acciaio	Codice Inox	Colore tappo	D	H	D1	L	D2	D3	H1	Confezione (pz)
KP02471067X15	KP024701067X15	G1	21	22	M6	15	14	19	8	1
KP02471067X20	KP024701067X20	G1	21	22	M6	20	14	19	8	1
KP02471067X25	KP024701067X25	G1	21	22	M6	25	14	19	8	1
KP02471067X30	KP024701067X30	G1	21	22	M6	30	14	19	8	1
KP0247208X20	KP02470208X20	GV	26	26	M8	20	18	23	9,5	1
KP0247208X25	KP02470208X25	GV	26	26	M8	25	18	23	9,5	1
KP0247208X30	KP02470208X30	GV	26	26	M8	30	18	23	9,5	1
KP0247208X40	KP02470208X40	GV	26	26	M8	40	18	23	9,5	1
KP02472085X20	KP024702085X20	G5	26	26	M8	20	18	23	9,5	1
KP02472085X25	KP024702085X25	G5	26	26	M8	25	18	23	9,5	1
KP02472085X30	KP024702085X30	G5	26	26	M8	30	18	23	9,5	1
KP02472085X40	KP024702085X40	G5	26	26	M8	40	18	23	9,5	1
KP02472086X20	KP024702086X20	R2	26	26	M8	20	18	23	9,5	1
KP02472086X25	KP024702086X25	R2	26	26	M8	25	18	23	9,5	1
KP02472086X30	KP024702086X30	R2	26	26	M8	30	18	23	9,5	1
KP02472086X40	KP024702086X40	R2	26	26	M8	40	18	23	9,5	1
KP02472087X20	KP024702087X20	G1	26	26	M8	20	18	23	9,5	1
KP02472087X25	KP024702087X25	G1	26	26	M8	25	18	23	9,5	1
KP02472087X30	KP024702087X30	G1	26	26	M8	30	18	23	9,5	1
KP02472087X40	KP024702087X40	G1	26	26	M8	40	18	23	9,5	1
KP0247310X20	KP02470310X20	GV	34	36	M10	20	22	31	13	1
KP0247310X30	KP02470310X30	GV	34	36	M10	30	22	31	13	1
KP0247310X40	KP02470310X40	GV	34	36	M10	40	22	31	13	1
KP02473105X20	KP024703105X20	G5	34	36	M10	20	22	31	13	1
KP02473105X30	KP024703105X30	G5	34	36	M10	30	22	31	13	1
KP02473105X40	KP024703105X40	G5	34	36	M10	40	22	31	13	1
KP02473106X20	KP024703106X20	R2	34	36	M10	20	22	31	13	1
KP02473106X30	KP024703106X30	R2	34	36	M10	30	22	31	13	1
KP02473106X40	KP024703106X40	R2	34	36	M10	40	22	31	13	1
KP02473107X20	KP024703107X20	G1	34	36	M10	20	22	31	13	1
KP02473107X30	KP024703107X30	G1	34	36	M10	30	22	31	13	1
KP02473107X40	KP024703107X40	G1	34	36	M10	40	22	31	13	1





MATERIALE - TRATTAMENTO SUPERFICIALE

Impugnatura: TMP (Termoplastico)
Boccola: Cl 5.8 (Acciaio) zincato bianco
AISI303 (Inox)

COLORE

Impugnatura: GN Grigio nerastro
Tappo: GV Grigio RAL 7021
G5 Grigio RAL 7035
R2 Rosso RAL 3020
G1 Giallo RAL 1021

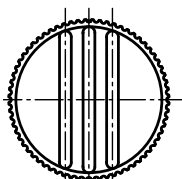
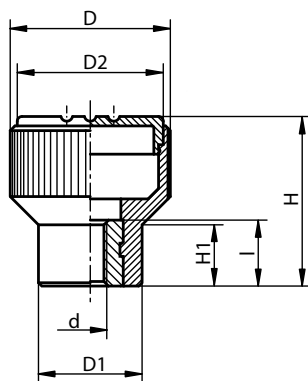

Codice Acciaio	Codice Inox	Colore tappo	D	H	d	l	D1	D2	H1	Confezione (pz)
KP0247104	KP02470104	GV	21	22	M4	10	14	19	8	1
KP02471045	KP024701045	G5	21	22	M4	10	14	19	8	1
KP02471046	KP024701046	R2	21	22	M4	10	14	19	8	1
KP02471047	KP024701047	G1	21	22	M4	10	14	19	8	1
KP0247105	KP02470105	GV	21	22	M5	10	14	19	8	1
KP02471055	KP024701055	G5	21	22	M5	10	14	19	8	1
KP02471056	KP024701056	R2	21	22	M5	10	14	19	8	1
KP02471057	KP024701057	G1	21	22	M5	10	14	19	8	1
KP0247106	KP02470106	GV	21	22	M6	10	14	19	8	1
KP02471065	KP024701065	G5	21	22	M6	10	14	19	8	1
KP02471066	KP024701066	R2	21	22	M6	10	14	19	8	1
KP02471067	KP024701067	G1	21	22	M6	10	14	19	8	1
KP0247308	KP02470308	GV	34	36	M8	14	22	31	13	1
KP02473085	KP024703085	G5	34	36	M8	14	22	31	13	1
KP02473086	KP024703086	R2	34	36	M8	14	22	31	13	1
KP02473087	KP024703087	G1	34	36	M8	14	22	31	13	1
KP0247208	KP02470208	GV	26	26	M8	14	18	23	9,5	1
KP02472085	KP024702085	G5	26	26	M8	14	18	23	9,5	1
KP02472086	KP024702086	R2	26	26	M8	14	18	23	9,5	1
KP02472087	KP024702087	G1	26	26	M8	14	18	23	9,5	1
KP0247310	KP02470310	GV	34	36	M10	14	22	31	13	1
KP02473105	KP024703105	G5	34	36	M10	14	22	31	13	1
KP02473106	KP024703106	R2	34	36	M10	14	22	31	13	1
KP02473107	KP024703107	G1	34	36	M10	14	22	31	13	1



MATERIALE - FINITURA

Impugnatura: AL (Alluminio) burattato

Perno: AISI303 (Inox)

Spina: AISI301 (Inox)

NOTE

Fornibili non trattati (non burattati).

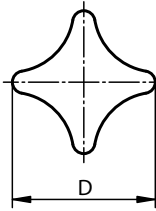
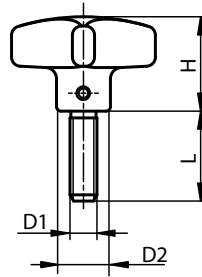

Codice	D	H	D1	L	D2	Confezione (pz)
KP0145604008X20	40	25	M8	20	14	1
KP0145604008X25	40	25	M8	25	14	1
KP0145604008X30	40	25	M8	30	14	1
KP0145604008X40	40	25	M8	40	14	1
KP0145604008X50	40	25	M8	50	14	1
KP0145605010X20	50	32	M10	20	18	1
KP0145605010X25	50	32	M10	25	18	1

Codice	D	H	D1	L	D2	Confezione (pz)
KP0145605010X30	50	32	M10	30	18	1
KP0145605010X40	50	32	M10	40	18	1
KP0145605010X50	50	32	M10	50	18	1
KP0145606312X20	63	40	M12	20	25	1
KP0145606312X30	63	40	M12	30	25	1
KP0145606312X40	63	40	M12	40	25	1
KP0145606312X50	63	40	M12	50	25	1

MATERIALE - FINITURA

Impugnatura: AL (Alluminio) burattato

AL (Alluminio) rettificato e lucidato

NOTE

Fornibili non trattati (non burattati).

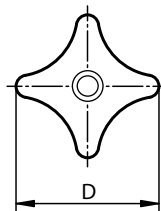
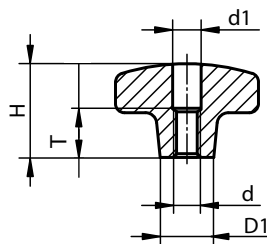

Codice burattato	Codice lucidato	D	H	d	D1	T	d1	Confezione (pz)
KP0145404008	KP01454040082	40	25	M8	14	15	8,4	1
KP0145405010	KP01454050102	50	32	M10	18	18	10,5	1

Codice burattato	Codice lucidato	D	H	d	D1	T	d1	Confezione (pz)
KP0145406312	KP01454063122	63	40	M12	25	22	13	1
KP0145408016	KP01454080162	80	50	M16	25	28	17	1

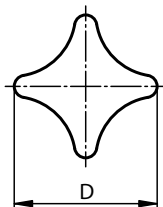
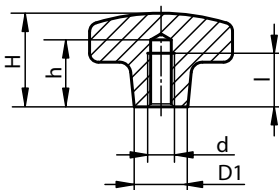

MATERIALE - FINITURA

Impugnatura: AL (Alluminio) burattato
AL (Alluminio) rettificato e lucidato

NOTE

Fornibili non trattati (non burattati).

Codice burattato	Codice lucidato	D	H	d	l	D1	h	Confezione (pz)
KP0145504008	KP01455040082	40	25	M8	15	14	18	1
KP0145505010	KP01455050102	50	32	M10	18	18	21	1

Codice burattato	Codice lucidato	D	H	d	l	D1	h	Confezione (pz)
KP0145506312	KP01455063122	63	40	M12	22	25	25	1
KP0145508016	KP01455080162	80	50	M16	28	25	32	1

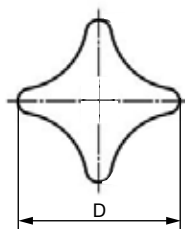
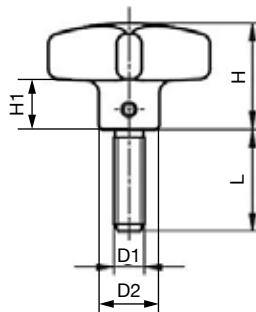

MATERIALE

Impugnatura: 1.4308 (Inox)
Perno: AISI303 (Inox)
Spina: AISI301 (Inox)

Codice	D	H	D1	L	D2	H1	Confezione (pz)
KP01466032063X15	32	21	M6	15	12	10	1
KP01466032063X20	32	21	M6	20	12	10	1
KP01466032063X25	32	21	M6	25	12	10	1
KP01466032063X30	32	21	M6	30	12	10	1
KP01466032063X40	32	21	M6	40	12	10	1
KP01466032063X50	32	21	M6	50	12	10	1
KP01466040083X20	40	26	M8	20	14	14	1
KP01466040083X25	40	26	M8	25	14	14	1
KP01466040083X30	40	26	M8	30	14	14	1
KP01466040083X40	40	26	M8	40	14	14	1

Codice	D	H	D1	L	D2	H1	Confezione (pz)
KP01466040083X50	40	26	M8	50	14	14	1
KP01466050103X20	50	34	M10	20	18	20	1
KP01466050103X25	50	34	M10	25	18	20	1
KP01466050103X30	50	34	M10	30	18	20	1
KP01466050103X40	50	34	M10	40	18	20	1
KP01466050103X50	50	34	M10	50	18	20	1
KP01466063123X20	63	42	M12	20	20	25	1
KP01466063123X30	63	42	M12	30	20	25	1
KP01466063123X40	63	42	M12	40	20	25	1
KP01466063123X50	63	42	M12	50	20	25	1



MATERIALE - FINITURA

1.4308 (Inox) rettificato e lucidato
1.4308 (Inox) rettificato e sabbiato

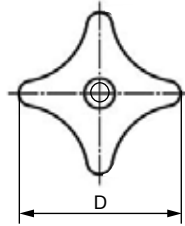
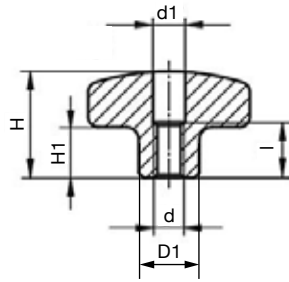

Codice lucidato	Codice sabbiato	D	H	d	l	D1	H1	d1	Confezione (pz)
KP01464032062	KP01464032063	32	21	M6	11	12	10	6,4	1
KP01464040082	KP01464040083	40	26	M8	14	14	14	8,4	1

Codice lucidato	Codice sabbiato	D	H	d	l	D1	H1	d1	Confezione (pz)
KP01464050102	KP01464050103	50	34	M10	18	18	20	10,5	1
KP01464063122	KP01464063123	63	42	M12	22	20	25	13	1

MATERIALE - FINITURA

1.4308 (Inox) rettificato e lucidato
1.4308 (Inox) rettificato e sabbiato

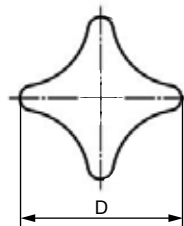
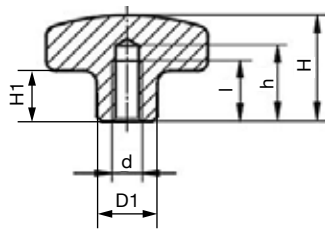

Codice lucidato	Codice sabbiato	D	H	d	l	D1	H1	h	Confezione (pz)
KP01465032062	KP01465032063	32	21	M6	12	12	10	15	1
KP01465040082	KP01465040083	40	26	M8	15	14	14	18	1

Codice lucidato	Codice sabbiato	D	H	d	l	D1	H1	h	Confezione (pz)
KP01465050102	KP01465050103	50	34	M10	18	18	20	21	1
KP01465063122	KP01465063123	63	42	M12	22	20	25	25	1

1
2
3
4
5
6
7
8
9
10
11
12
13
14
15
16
17
18
19
20
21

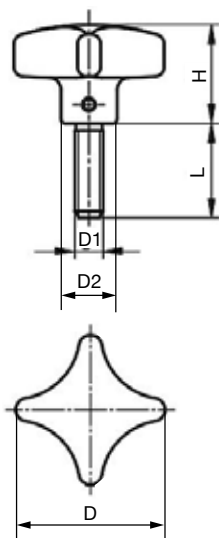

MATERIALE - FINITURA

Impugnatura: GJL200 (Ghisa) burattata
Perno: AISI303 (Inox)
Spina: AISI301 (Inox)

Codice	D	H	D1	L	D2	Confezione (pz)
KP0147606X15	32	20	M6	15	12	1
KP0147606X20	32	20	M6	20	12	1
KP0147606X25	32	20	M6	25	12	1
KP0147606X30	32	20	M6	30	12	1
KP0147606X40	32	20	M6	40	12	1
KP0147606X50	32	20	M6	50	12	1
KP0147608X20	40	25	M8	20	14	1
KP0147608X25	40	25	M8	25	14	1
KP0147608X30	40	25	M8	30	14	1
KP0147608X40	40	25	M8	40	14	1

Codice	D	H	D1	L	D2	Confezione (pz)
KP0147608X50	40	25	M8	50	14	1
KP0147610X20	50	32	M10	20	18	1
KP0147610X25	50	32	M10	25	18	1
KP0147610X30	50	32	M10	30	18	1
KP0147610X40	50	32	M10	40	18	1
KP0147610X50	50	32	M10	50	18	1
KP0147612X20	63	40	M12	20	20	1
KP0147612X30	63	40	M12	30	20	1
KP0147612X40	63	40	M12	40	20	1
KP0147612X50	63	40	M12	50	20	1

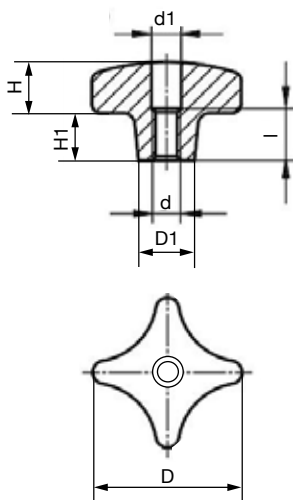

MATERIALE - FINITURA

Impugnatura: GJL200 (Ghisa) burattata

Codice	D	H	d	I	D1	H1	d1	Confezione (pz)
KP0147406	32	20	M6	10	12	10	6,4	1
KP0147408	40	25	M8	13	14	14	8,4	1
KP0147410	50	32	M10	16	18	20	10,5	1

Codice	D	H	d	I	D1	H1	d1	Confezione (pz)
KP0147412	63	40	M12	20	20	25	13	1
KP0147416	80	50	M16	20	25	30	17	1
KP0147420	100	63	M20	25	32	38	21	1

MATERIALE - FINITURA

Impugnatura: G.JL200 (Ghisa) burattata

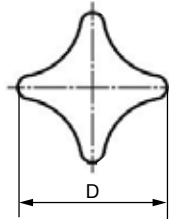
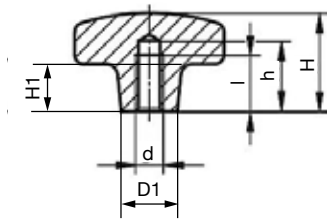

Codice	D	H	d	l	D1	H1	h	Confezione (pz)
KP0147506	32	20	M6	12	12	10	15	1
KP0147508	40	25	M8	15	14	14	18	1
KP0147510	50	32	M10	18	18	20	21	1

Codice	D	H	d	l	D1	H1	h	Confezione (pz)
KP0147512	63	40	M12	22	20	25	25	1
KP0147516	80	50	M16	28	25	30	32	1
KP0147520	100	63	M20	36	32	38	40	1

GALLETTO DI SERRAGGIO
 inox

KP027-C
MATERIALE - FINITURA

 AISI304 (Inox) rettificato lucidato
 AISI304 (Inox) rettificato sabbato

NOTE

Fornibile con filettatura esterna.

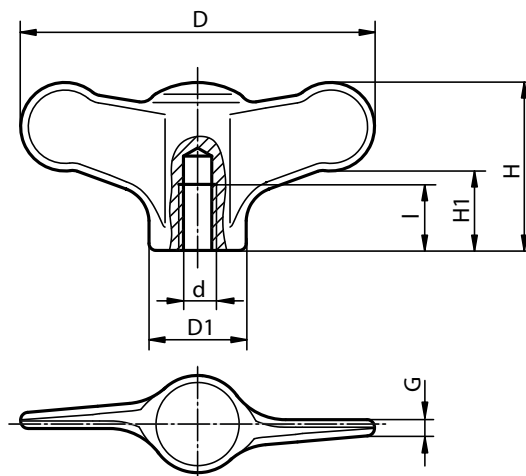

Codice lucidato	Codice sabbato	D	H	d	l	D1	H1	G	Confezione (pz)
KP0273904	KP02739041	38	18	M4	9	10,5	8,5	1,7	1
KP0273905	KP02739051	38	18	M5	9	10,5	8,5	1,7	1
KP0273906	KP02739061	38	18	M6	9	10,5	8,5	1,7	1
KP0273105	KP02731051	50	24	M5	12	14	11,5	2,3	1

Codice lucidato	Codice sabbato	D	H	d	l	D1	H1	G	Confezione (pz)
KP0273106	KP02731061	50	24	M6	12	14	11,5	2,3	1
KP0273208	KP02732081	75	35	M8	15	21	16,5	3,4	1
KP0273210	KP02732101	75	35	M10	15	21	16,5	3,4	1

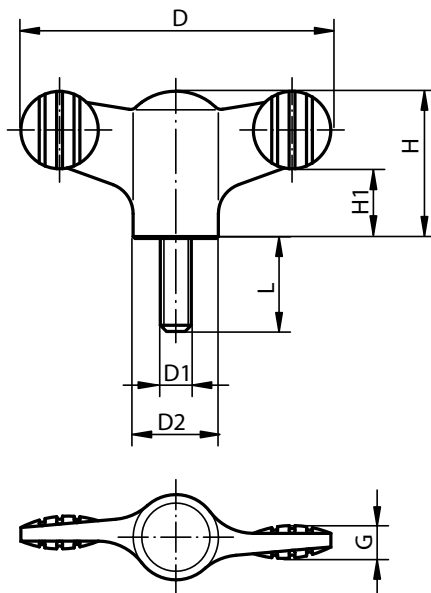

MATERIALE - TRATTAMENTO SUPERFICIALE

Impugnatura: TMP (Termoplastico)

Perno: C1 5.8 (Acciaio) zincato bianco
AISI303 (Inox)

COLORE

Impugnatura: GN Grigio nerastro

Tappo: GV Grigio RAL 7021

G5 Grigio RAL 7035

R2 Rosso RAL 3020

G1 Giallo RAL 1021

Codice Acciaio	Codice Inox	Colore tappo	D	H	D1	L	D2	H1	G	Confezione (pz)
KP0274904X10	KP02740904X10	GV	38	18	M4	10	12	8,5	4,5	1
KP0274904X15	KP02740904X15	GV	38	18	M4	15	12	8,5	4,5	1
KP02749045X10	KP027409045X10	G5	38	18	M4	10	12	8,5	4,5	1
KP02749045X15	KP027409045X15	G5	38	18	M4	15	12	8,5	4,5	1
KP02749046X10	KP027409046X10	R2	38	18	M4	10	12	8,5	4,5	1
KP02749046X15	KP027409046X15	R2	38	18	M4	15	12	8,5	4,5	1
KP02749047X10	KP027409047X10	G1	38	18	M4	10	12	8,5	4,5	1
KP02749047X15	KP027409047X15	G1	38	18	M4	15	12	8,5	4,5	1
KP0274905X15	KP02740905X15	GV	38	18	M5	15	12	8,5	4,5	1
KP0274905X20	KP02740905X20	GV	38	18	M5	20	12	8,5	4,5	1
KP0274905X30	KP02740905X30	GV	38	18	M5	30	12	8,5	4,5	1
KP02749055X15	KP027409055X15	G5	38	18	M5	15	12	8,5	4,5	1
KP02749055X20	KP027409055X20	G5	38	18	M5	20	12	8,5	4,5	1
KP02749055X30	KP027409055X30	G5	38	18	M5	30	12	8,5	4,5	1
KP02749056X15	KP027409056X15	R2	38	18	M5	15	12	8,5	4,5	1
KP02749056X20	KP027409056X20	R2	38	18	M5	20	12	8,5	4,5	1
KP02749056X30	KP027409056X30	R2	38	18	M5	30	12	8,5	4,5	1
KP02749057X15	KP027409057X15	G1	38	18	M5	15	12	8,5	4,5	1
KP02749057X20	KP027409057X20	G1	38	18	M5	20	12	8,5	4,5	1
KP02749057X30	KP027409057X30	G1	38	18	M5	30	12	8,5	4,5	1
KP0274906X20	KP02740906X20	GV	38	18	M6	20	12	8,5	4,5	1
KP0274906X30	KP02740906X30	GV	38	18	M6	30	12	8,5	4,5	1
KP0274906X40	KP02740906X40	GV	38	18	M6	40	12	8,5	4,5	1
KP02749065X20	KP027409065X20	G5	38	18	M6	20	12	8,5	4,5	1
KP02749065X30	KP027409065X30	G5	38	18	M6	30	12	8,5	4,5	1
KP02749065X40	KP027409065X40	G5	38	18	M6	40	12	8,5	4,5	1
KP02749066X20	KP027409066X20	R2	38	18	M6	20	12	8,5	4,5	1
KP02749066X30	KP027409066X30	R2	38	18	M6	30	12	8,5	4,5	1
KP02749066X40	KP027409066X40	R2	38	18	M6	40	12	8,5	4,5	1
KP02749067X20	KP027409067X20	G1	38	18	M6	20	12	8,5	4,5	1
KP02749067X30	KP027409067X30	G1	38	18	M6	30	12	8,5	4,5	1
KP02749067X40	KP027409067X40	G1	38	18	M6	40	12	8,5	4,5	1



MATERIALE - TRATTAMENTO SUPERFICIALE

Impugnatura: TMP (Termoplastico)
Perno: CI 5.8 (Acciaio) zincato bianco
AISI303 (Inox)

COLORE

Impugnatura: Grigio nerastro
Tappo: Grigio RAL 7021
 Grigio RAL 7035
 Rosso RAL 3020
 Giallo RAL 1021

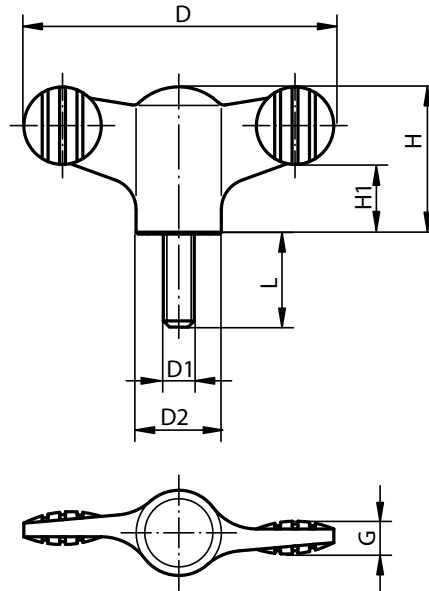

Codice Acciaio	Codice Inox	Colore tappo	D	H	D1	L	D2	H1	G	Confezione (pz)
KP0274105X15	KP02740105X15		50	24	M5	15	14	11,5	5	1
KP0274105X20	KP02740105X20		50	24	M5	20	14	11,5	5	1
KP02741055X15	KP027401055X15		50	24	M5	15	14	11,5	5	1
KP02741055X20	KP027401055X20		50	24	M5	20	14	11,5	5	1
KP02741056X15	KP027401056X15		50	24	M5	15	14	11,5	5	1
KP02741056X20	KP027401056X20		50	24	M5	20	14	11,5	5	1
KP02741057X15	KP027401057X15		50	24	M5	15	14	11,5	5	1
KP02741057X20	KP027401057X20		50	24	M5	20	14	11,5	5	1
KP0274106X20	KP02740106X20		50	24	M6	20	14	11,5	5	1
KP0274106X30	KP02740106X30		50	24	M6	30	14	11,5	5	1
KP0274106X40	KP02740106X40		50	24	M6	40	14	11,5	5	1
KP02741065X20	KP027401065X20		50	24	M6	20	14	11,5	5	1
KP02741065X30	KP027401065X30		50	24	M6	30	14	11,5	5	1
KP02741065X40	KP027401065X40		50	24	M6	40	14	11,5	5	1
KP02741066X20	KP027401066X20		50	24	M6	20	14	11,5	5	1
KP02741066X30	KP027401066X30		50	24	M6	30	14	11,5	5	1
KP02741066X40	KP027401066X40		50	24	M6	40	14	11,5	5	1
KP02741067X20	KP027401067X20		50	24	M6	20	14	11,5	5	1
KP02741067X30	KP027401067X30		50	24	M6	30	14	11,5	5	1
KP02741067X40	KP027401067X40		50	24	M6	40	14	11,5	5	1
KP0274108X20	KP02740108X20		50	24	M8	20	14	11,5	5	1
KP0274108X30	KP02740108X30		50	24	M8	30	14	11,5	5	1
KP0274108X40	KP02740108X40		50	24	M8	40	14	11,5	5	1
KP02741085X20	KP027401085X20		50	24	M8	20	14	11,5	5	1
KP02741085X30	KP027401085X30		50	24	M8	30	14	11,5	5	1
KP02741085X40	KP027401085X40		50	24	M8	40	14	11,5	5	1
KP02741086X20	KP027401086X20		50	24	M8	20	14	11,5	5	1
KP02741086X30	KP027401086X30		50	24	M8	30	14	11,5	5	1
KP02741086X40	KP027401086X40		50	24	M8	40	14	11,5	5	1
KP02741087X20	KP027401087X20		50	24	M8	20	14	11,5	5	1
KP02741087X30	KP027401087X30		50	24	M8	30	14	11,5	5	1
KP02741087X40	KP027401087X40		50	24	M8	40	14	11,5	5	1

1
2
3
4
5
6
7
8
9
10
11
12
13
14
15
16
17
18
19
20
21

MATERIALE - TRATTAMENTO SUPERFICIALE

Impugnatura: TMP (Termoplastico)

Perno: C1 5.8 (Acciaio) zincato bianco
AISI303 (Inox)

COLORE

- Impugnatura:** GN Grigio nerastro
Tappo: GV Grigio RAL 7021
G5 Grigio RAL 7035
R2 Rosso RAL 3020
G1 Giallo RAL 1021

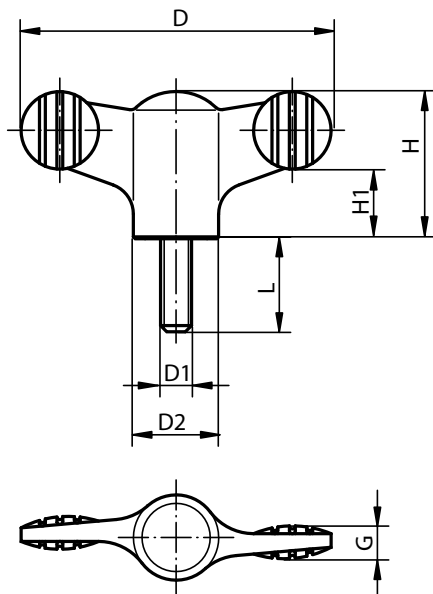

Codice Acciaio	Codice Inox	Colore tappo	D	H	D1	L	D2	H1	G	Confezione (pz)
KP0274208X20	KP02740208X20	GV	75	35,6	M8	20	21	16,5	7	1
KP0274208X30	KP02740208X30	GV	75	35,6	M8	30	21	16,5	7	1
KP0274208X40	KP02740208X40	GV	75	35,6	M8	40	21	16,5	7	1
KP02742085X20	KP027402085X20	G5	75	35,6	M8	20	21	16,5	7	1
KP02742085X30	KP027402085X30	G5	75	35,6	M8	30	21	16,5	7	1
KP02742085X40	KP027402085X40	G5	75	35,6	M8	40	21	16,5	7	1
KP02742086X20	KP027402086X20	R2	75	35,6	M8	20	21	16,5	7	1
KP02742086X30	KP027402086X30	R2	75	35,6	M8	30	21	16,5	7	1
KP02742086X40	KP027402086X40	R2	75	35,6	M8	40	21	16,5	7	1
KP02742087X20	KP027402087X20	G1	75	35,6	M8	20	21	16,5	7	1
KP02742087X30	KP027402087X30	G1	75	35,6	M8	30	21	16,5	7	1
KP02742087X40	KP027402087X40	G1	75	35,6	M8	40	21	16,5	7	1
KP0274210X20	KP02740210X20	GV	75	35,6	M10	20	21	16,5	7	1
KP0274210X30	KP02740210X30	GV	75	35,6	M10	30	21	16,5	7	1
KP0274210X40	KP02740210X40	GV	75	35,6	M10	40	21	16,5	7	1
KP0274210X50	KP02740210X50	GV	75	35,6	M10	50	21	16,5	7	1
KP02742105X20	KP027402105X20	G5	75	35,6	M10	20	21	16,5	7	1
KP02742105X30	KP027402105X30	G5	75	35,6	M10	30	21	16,5	7	1
KP02742105X40	KP027402105X40	G5	75	35,6	M10	40	21	16,5	7	1
KP02742105X50	KP027402105X50	G5	75	35,6	M10	50	21	16,5	7	1
KP02742106X20	KP027402106X20	R2	75	35,6	M10	20	21	16,5	7	1
KP02742106X30	KP027402106X30	R2	75	35,6	M10	30	21	16,5	7	1
KP02742106X40	KP027402106X40	R2	75	35,6	M10	40	21	16,5	7	1
KP02742106X50	KP027402106X50	R2	75	35,6	M10	50	21	16,5	7	1
KP02742107X20	KP027402107X20	G1	75	35,6	M10	20	21	16,5	7	1
KP02742107X30	KP027402107X30	G1	75	35,6	M10	30	21	16,5	7	1
KP02742107X40	KP027402107X40	G1	75	35,6	M10	40	21	16,5	7	1
KP02742107X50	KP027402107X50	G1	75	35,6	M10	50	21	16,5	7	1



MATERIALE - TRATTAMENTO SUPERFICIALE

Impugnatura: TMP (Termoplastico)
Boccola: Cl 5.8 (Acciaio) zincato bianco
AISI303 (Inox)

COLORE

Impugnatura: GN Grigio nerastro
Tappo: GV Grigio RAL 7021
G5 Grigio RAL 7035
R2 Rosso RAL 3020
G1 Giallo RAL 1021

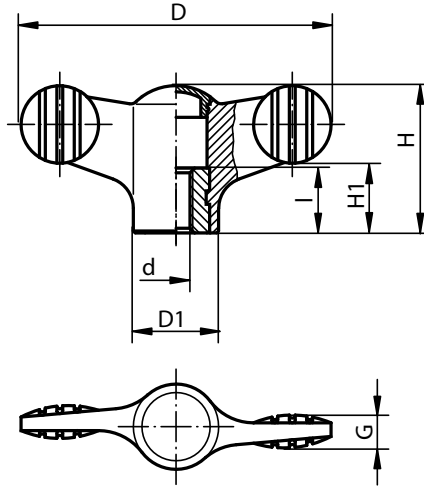

Codice Acciaio	Codice Inox	Colore tappo	D	H	d	l	D1	H1	G	Confezione (pz)
KP0274904	KP02740904	GV	38	18	M4	10	12	8,5	4,5	1
KP02749045	KP027409045	G5	38	18	M4	10	12	8,5	4,5	1
KP02749046	KP027409046	R2	38	18	M4	10	12	8,5	4,5	1
KP02749047	KP027409047	G1	38	18	M4	10	12	8,5	4,5	1
KP0274905	KP02740905	GV	38	18	M5	10	12	8,5	4,5	1
KP02749055	KP027409055	G5	38	18	M5	10	12	8,5	4,5	1
KP02749056	KP027409056	R2	38	18	M5	10	12	8,5	4,5	1
KP02749057	KP027409057	G1	38	18	M5	10	12	8,5	4,5	1
KP0274906	KP02740906	GV	38	18	M6	10	12	8,5	4,5	1
KP02749065	KP027409065	G5	38	18	M6	10	12	8,5	4,5	1
KP02749066	KP027409066	R2	38	18	M6	10	12	8,5	4,5	1
KP02749067	KP027409067	G1	38	18	M6	10	12	8,5	4,5	1
KP0274105	KP02740105	GV	50	24	M5	10	14	11,5	5	1
KP02741055	KP027401055	G5	50	24	M5	10	14	11,5	5	1
KP02741056	KP027401056	R2	50	24	M5	10	14	11,5	5	1
KP02741057	KP027401057	G1	50	24	M5	10	14	11,5	5	1
KP0274106	KP02740106	GV	50	24	M6	10	14	11,5	5	1
KP02741065	KP027401065	G5	50	24	M6	10	14	11,5	5	1
KP02741066	KP027401066	R2	50	24	M6	10	14	11,5	5	1
KP02741067	KP027401067	G1	50	24	M6	10	14	11,5	5	1
KP0274208	KP02740208	GV	75	35,6	M8	14	21	16,5	7	1
KP02742085	KP027402085	G5	75	35,6	M8	14	21	16,5	7	1
KP02742086	KP027402086	R2	75	35,6	M8	14	21	16,5	7	1
KP02742087	KP027402087	G1	75	35,6	M8	14	21	16,5	7	1
KP0274210	KP02740210	GV	75	35,6	M10	14	21	16,5	7	1
KP02742105	KP027402105	G5	75	35,6	M10	14	21	16,5	7	1
KP02742106	KP027402106	R2	75	35,6	M10	14	21	16,5	7	1
KP02742107	KP027402107	G1	75	35,6	M10	14	21	16,5	7	1

1
2
3
4
5
6
7
8
9
10
11
12
13
14
15
16
17
18
19
20
21